

# Couplings & Equipment



# Couplings & Equipment Selector Guide

Series	Hose Application / Construction / Selector Guide		Size Range (in)	Page No.
S101CS	Crimp coupling	Male NPTF Pipe – Straight Rigid	3/4 - 1	384
S101HY	Crimp coupling	Male NPTF Pipe – Straight Rigid	1/4 - 1-1/4	375
S102HY	Crimp coupling	Female NPTF Pipe – Straight Rigid	1/4 - 1	376
S103HY	Crimp coupling	Male JIC 37° – Straight Rigid	1/4 - 1	376
S106HY	Crimp coupling	Female JIC 37° – Straight Swivel	1/4 - 1-1/4	377
S107HY	Crimp coupling	Female NPSM Pipe – Straight Swivel	1/4 - 1/2	377
S113HY	Crimp coupling	Male NPTF Pipe – Straight Swivel	1/4 - 1	378
S139HY	Crimp coupling	Female JIC 37° – Swivel 90° Elbow Short Drop	1/4 - 1	378
S1APWC	Crimp coupling, oil field	Male API – Straight Rigid	2	380
S101WC	Crimp coupling	Male NPTF Pipe – Straight Rigid	2	381
S106WC	Crimp coupling	Female JIC 37° – Straight Swivel	2	381
S10143	Crimp coupling	Male NPTF Pipe – Straight Rigid	1/4 - 2	379
S10643	Crimp coupling	Female JIC 37° – Straight Swivel	1/4 - 2	379
S11343	Crimp coupling	Male NPTF Pipe – Straight Swivel	1/4 - 1/2	380
S10171	Crimp coupling	Male NPTF Pipe – Straight Rigid	1-1/4 - 2	380
S20820	Reattachable coupling	Female SAE 45° – Straight Swivel	5/16	386
7610/CS	Crimp coupling, steam	Female Ground Joint NPSM with Wing Nut and O-Ring	3/4 - 1	385
7612	Spud adapter, steam	3/4" Female Pipe x 1-1/2" Ground Joint Male		385
7661/LA-FJ	Crimp coupling	Female JIC 37° – Straight Swivel	1	383
7661/LA-NP	Crimp coupling	Male NPTF Pipe – Straight Rigid	1	383
7661/LAR-FJ	Crimp coupling	Female JIC 37° – Straight Swivel with Internal O-Ring	1	384
7661/LAR-MP	Crimp coupling	Male NPTF Pipe – Straight Rigid with Internal O-Ring	1	384
7661/TY-FA	Crimp coupling	Female SAE 45° – Straight Swivel	1/4, 5/8	381
7661/TY-FF	Crimp coupling	Female NPTF Pipe – Straight Rigid	1/4	382
7661/TY-FJ	Crimp coupling	Female JIC 37° – Straight Swivel	1/4, 1/2	382
7661/TY-MP	Crimp coupling	Male NPTF Pipe – Straight Rigid	1/4, 1/2	382
7661/TY-SP	Crimp coupling	Male NPTF Pipe – Straight Swivel	1/2	383
CGHBL	Brass stem	Welding connection	3/4	386
HBL-C	Crimp coupling stem, DEF	Male NPTF Pipe – Straight Rigid (SS)	3/4	385
HBL-C	Crimp coupling stem, DEF	Male BSPP w/Seal – Straight Rigid (SS)	3/4	385
SMCP	Crimp ferrules, DEF	Nickel-Plated Brass	3/4	386
1000, 2100, 3100, 4100, 4500, 5100	Composite hose factory couplings	Aluminum, carbon steel, stainless steel	1 - 10	387
COS-K1	Adjustable crimper	1-1/4" ID hose capacity		388
COS-K2	Adjustable crimper	2" ID hose capacity		389
COS-K4	Adjustable crimper	4" ID hose capacity		390
660-T	Ferrule vise crimper, manual	1" ID hose capacity		392
670-T	Ferrule vise crimper, air powered	1" ID hose capacity		392

**NOTE:** This is a guide only. It is the responsibility of the end user to select and/or test the most appropriate product for the application. Refer to product pages for specific data. Contact Parker for additional information.

See pages ii through iv for an index of all product series by series number and pages v through xv for an index by application and by series name. Refer to pages 9-10 for a complete listing of industry standards.

Due to continual product improvements, Parker reserves the right to alter specifications without prior notice.



# Series HY

## S101HY Male NPTF Pipe – Straight Rigid

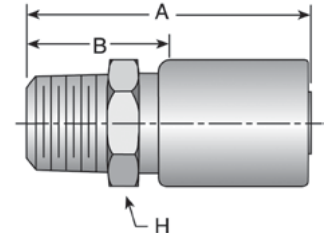

Part Number	Hose ID (in)	Thread ID (in)	Thread Dash Size	Dimensions					Std Pack Qty (per carton)	Approx Wt Per Ctn (lbs)	Stock Status **
				A (in)	A (mm)	H (in)	B (in)	B (mm)			
S101HY-2-4	1/4	1/8x27	-2	2.34	59	5/8	1.00	25	20	1.94	Y
S101HY-4-4	1/4	1/4x18	-4	2.53	64	9/16	1.19	30	25	2.73	Y
S101HY-4-6	3/8	1/4x18	-4	2.55	65	11/16	1.19	30	20	3.06	Y
S101HY-6-4	1/4	3/8x18	-6	2.53	64	3/4	1.19	30	20	2.68	Y
S101HY-6-6	3/8	3/8x18	-6	2.55	65	3/4	1.19	30	25	4.20	Y
S101HY-6-8	1/2	3/8x18	-6	2.72	69	7/8	1.38	35	20	4.54	Y
S101HY-8-6	3/8	1/2x14	-8	2.73	69	7/8	1.38	35	20	4.36	Y
S101HY-8-8	1/2	1/2x14	-8	2.91	74	7/8	1.41	40	25	6.53	Y
S101HY-8-10	5/8	1/2x14	-8	2.94	75	1-1/8	1.59	40	20	7.26	N
S101HY-8-12	3/4	1/2x14	-8	3.08	78	1-1/4	1.50	38	10	4.33	Y
S101HY-12-8	1/2	3/4x14	-12	2.91	74	1-1/16	1.56	40	20	7.60	Y
S101HY-12-10	5/8	3/4x14	-12	2.98	76	1-1/8	1.59	40	10	3.80	N
S101HY-12-12	3/4	3/4x14	-12	3.08	78	1-1/4	1.50	38	10	4.58	Y
S101HY-12-16	1	3/4x14	-12	3.23	82	1-3/8	1.63	41	10	5.40	N
S101HY-16-12	3/4	1x11-1/2	-16	3.27	83	1-3/8	1.69	43	10	5.10	Y
S101HY-16-16	1	1x11-1/2	-16	3.42	87	1-3/8	1.81	46	10	6.29	Y
S101HY-20-20	1-1/4	1-1/4 x 11-1/2	-20	3.84	98	1-3/4	2.00	51	4	6.62	Y

\*\* Stock: "Y" indicates stocked item; "N" indicates non-stocked item. Stock status subject to change. Contact Parker Customer Service.

**Couplings:** Refer to CrimpSource at [www.safehose.com](http://www.safehose.com) for coupling recommendations and crimp specifications.

## Series HY S102HY Female NPTF Pipe – Straight Rigid

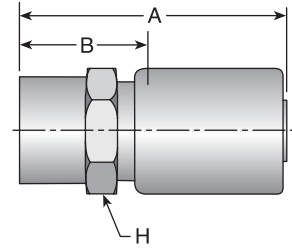

Part Number	Hose ID (in)	Thread ID (in)	Thread Dash Size	Dimensions					Std Pack Qty (per carton)	Approx Wt Per Ctn (lbs)	Stock Status **
				A (in)	A (mm)	H (in)	B (in)	B (mm)			
S102HY-2-4	1/4	1/8x27	-2	2.34	59	5/8	1.00	25	20	2.24	N
S102HY-4-4	1/4	1/4x18	-4	2.47	63	11/16	1.13	29	25	3.23	Y
S102HY-4-6	3/8	1/4x18	-4	2.48	63	11/16	1.13	29	20	2.94	N
S102HY-6-4	1/4	3/8x18	-6	2.47	63	7/8	1.13	29	20	2.94	N
S102HY-6-6	3/8	3/8x18	-6	2.48	63	7/8	1.13	29	25	4.58	N
S102HY-8-6	3/8	1/2x14	-8	2.75	70	1	1.41	36	25	5.53	N
S102HY-8-8	1/2	1/2x14	-8	2.84	72	1	1.50	38	25	6.98	N
S102HY-12-12	3/4	3/4x14	-12	2.83	72	1-1/4	1.25	32	10	4.05	N
S102HY-16-16	1	1x11-1/2	-16	3.27	83	1-1/2	1.66	42	10	6.18	N

\*\* Stock: "Y" indicates stocked item; "N" indicates non-stocked item. Stock status subject to change. Contact Parker Customer Service.

## Series HY S103HY Male JIC 37° – Straight Rigid

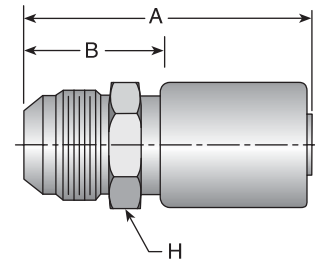

Part Number	Hose ID (in)	Thread ID (in)	Thread Dash Size	Dimensions					Std Pack Qty (per carton)	Approx Wt Per Ctn (lbs)	Stock Status **
				A (in)	A (mm)	H (in)	B (in)	B (mm)			
S103HY-4-4	1/4	7/16x20	-4	2.52	64	5/8	1.19	30	25	2.75	Y
S103HY-6-4	1/4	9/16x18	-6	2.53	64	11/16	1.19	30	20	2.68	Y
S103HY-6-6	3/8	9/16x18	-6	2.54	65	11/16	1.19	30	25	3.80	Y
S103HY-6-8	1/2	9/16x18	-6	2.72	69	7/8	1.38	35	25	5.50	N
S103HY-8-6	3/8	3/4x16	-8	2.64	67	13/16	1.28	33	20	3.96	Y
S103HY-8-8	1/2	3/4x16	-8	2.81	71	5/8	1.47	37	25	6.10	Y
S103HY-10-8	1/2	7/8x14	-10	2.91	74	1	1.56	40	20	5.60	Y
S103HY-10-10	5/8	7/8x14	-10	2.98	76	1-1/8	1.59	40	25	9.08	N
S103HY-10-12	3/4	7/8x14	-10	3.08	78	1-1/4	1.50	38	5	2.23	N
S103HY-12-8	1/2	1-1/16x12	-12	3.02	77	1-1/8	1.66	42	25	8.98	N
S103HY-12-10	5/8	1-1/16x12	-12	3.09	78	1-1/8	1.72	44	25	9.65	N
S103HY-12-12	3/4	1-1/16x12	-12	3.19	81	1-1/4	1.63	41	10	4.60	Y
S103HY-16-12	3/4	1-5/16x12	-16	3.23	82	1-3/8	1.66	42	10	5.29	N
S103HY-16-16	1	1-5/16x12	-16	3.39	86	1-3/8	1.78	45	10	6.44	N

\*\* Stock: "Y" indicates stocked item; "N" indicates non-stocked item. Stock status subject to change. Contact Parker Customer Service.

**Couplings:** Refer to CrimpSource at [www.safehose.com](http://www.safehose.com) for coupling recommendations and crimp specifications.



## Series HY

### S106HY Female JIC 37° – Straight Swivel

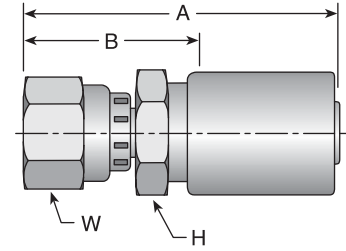

Part Number	Hose ID (in)	Thread ID (in)	Thread Dash Size	Dimensions						Std Pack Qty (per carton)	Approx Wt Per Ctn (lbs)	Stock Status **
				A (in)	A (mm)	H (in)	W (in)	B (in)	B (mm)			
S106HY-4-4	1/4	7/16x20	-4	2.60	66	9/16	9/16	1.25	32	25	3.18	Y
S106HY-4-6	3/8	7/16x20	-4	2.67	68	3/4	9/16	1.31	33	20	3.30	Y
S106HY-5-4	1/4	1/2x20	-5	2.65	67	9/16	5/8	1.31	33	20	2.52	Y
S106HY-6-4	1/4	9/16x18	-6	2.67	68	5/8	11/16	1.31	33	20	2.62	Y
S106HY-6-6	3/8	9/16x18	-6	2.69	68	11/16	11/16	1.34	34	50	8.35	Y
S106HY-6-8	1/2	9/16x18	-6	2.86	73	7/8	9/16	1.50	38	20	4.80	N
S106HY-8-6	3/8	3/4x16	-8	2.72	69	7/8	7/8	1.38	35	20	3.96	Y
S106HY-8-8	1/2	3/4x16	-8	2.90	74	7/8	7/8	1.56	40	50	13.20	Y
S106HY-8-10	5/8	3/4x16	-8	2.98	76	1-1/8	7/8	1.59	40	20	7.06	N
S106HY-8-12	3/4	3/4x16	-8	3.08	78	1-1/4	7/8	1.53	39	10	2.64	N
S106HY-10-8	1/2	7/8x14	-10	2.98	76	1	1	1.63	41	20	6.20	Y
S106HY-10-10	5/8	7/8x14	-10	3.06	78	1-1/8	1	1.69	43	25	9.95	Y
S106HY-10-12	3/4	7/8x14	-10	3.16	80	1-1/4	1	1.59	40	10	5.23	N
S106HY-12-8	1/2	1-1/16x12	-12	3.05	77	1-1/8	1-1/4	1.69	43	10	3.84	Y
S106HY-12-10	5/8	1-1/16x12	-12	3.12	79	1-1/8	1-1/4	1.75	44	10	4.48	Y
S106HY-12-12	3/4	1-1/16x12	-12	3.22	82	1-1/4	1-1/4	1.66	42	25	13.08	Y
S106HY-12-16	1	1-1/16x12	-12	3.38	86	1-3/8	1-1/4	1.75	44	10	6.40	N
S106HY-16-16	1	1-5/16x12	-16	3.45	88	1-3/8	1-1/2	1.84	47	10	6.86	Y
S106HY-20-20	1-1/4	1-5/8x12	-20	4.09	104	2	2	2.25	57	4	5.00	Y

\*\* Stock: "Y" indicates stocked item; "N" indicates non-stocked item. Stock status subject to change. Contact Parker Customer Service.

## Series HY

### S107HY Female NPSM Pipe – Straight Swivel

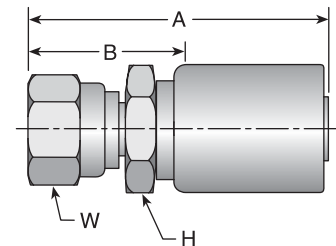

Part Number	Hose ID (in)	Thread ID (in)	Thread Dash Size	Dimensions						Std Pack Qty (per carton)	Approx Wt Per Ctn (lbs)	Stock Status **
				A (in)	A (mm)	H (in)	W (in)	B (in)	B (mm)			
S107HY-4-4	1/4	1/4x18	-4	2.66	68	9/16	11/16	1.31	33	20	2.76	N
S107HY-6-6	3/8	3/8x18	-6	2.55	65	3/4	7/8	1.19	30	25	5.25	Y
S107HY-8-8	1/2	1/2x14	-8	2.91	74	3/4	1	1.56	40	25	7.55	N

\*\* Stock: "Y" indicates stocked item; "N" indicates non-stocked item. Stock status subject to change. Contact Parker Customer Service.

**Couplings:** Refer to CrimpSource at [www.safehose.com](http://www.safehose.com) for coupling recommendations and crimp specifications.

**Parker Industrial Hose Customer Service**  
 866 810 HOSE (4673) 800 242 HOSE (4673)  
 Strongsville, OH South Gate, CA  
 Eastern USA Western USA

[www.safehose.com](http://www.safehose.com)  
 e-mail: [indhose@parker.com](mailto:indhose@parker.com)

## Series HY S113HY Male NPTF Pipe – Straight Swivel

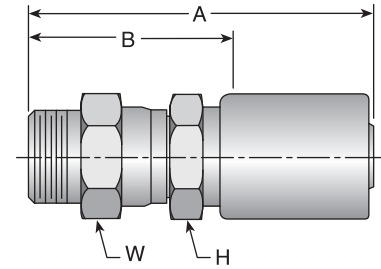

Part Number	Hose ID (in)	Thread ID (in)	Thread Dash Size	Dimensions						Std Pack Qty (per carton)	Approx Wt Per Ctn (lbs)	Stock Status **
				A (in)	A (mm)	H (in)	W (in)	B (in)	B (mm)			
S113HY-4-4	1/4	1/4x18	-4	3.06	78	9/16	5/8	1.72	44	25	2.95	Y
S113HY-6-6	3/8	3/8x18	-6	3.11	79	11/16	11/16	1.75	44	25	6.23	Y
S113HY-8-8	1/2	1/2x14	-8	3.50	89	7/8	7/8	2.16	55	25	8.55	Y
S113HY-12-12	3/4	3/4x14	-12	3.95	100	1-1/4	1-1/4	2.38	60	10	7.50	Y
S113HY-16-16	1	1x11-1/2	-16	4.23	107	1-1/2	1-1/2	2.63	67	10	11.52	Y

\*\* Stock: "Y" indicates stocked item; "N" indicates non-stocked item. Stock status subject to change. Contact Parker Customer Service.

## Series HY S139HY Female JIC 37° – 90° Swivel Short Drop Elbow

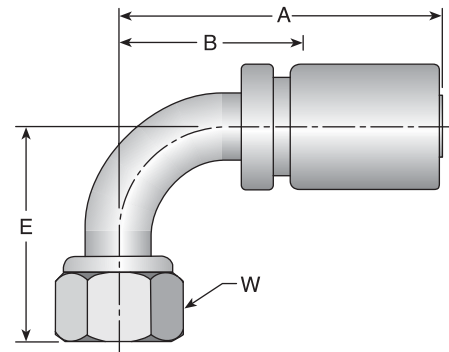

Part Number	Hose ID (in)	Thread ID (in)	Thread Dash Size	Dimensions						Std Pack Qty (per carton)	Approx Wt Per Ctn (lbs)	Stock Status **	
				A (in)	A (mm)	E (in)	E (mm)	W (in)	B (in)				B (mm)
S139HY-4-4	1/4	7/16x20	-4	2.40	61	0.83	21	9/16	1.13	29	10	1.47	Y
S139HY-6-4	1/4	9/16x18	-6	2.65	67	0.91	23	3/4	1.38	35	10	1.63	Y
S139HY-6-6	3/8	9/16x18	-6	2.57	65	0.91	23	11/16	1.29	33	10	2.17	Y
S139HY-8-6	3/8	3/4x16	-8	2.64	67	1.14	29	7/8	1.37	35	10	2.70	Y
S139HY-8-8	1/2	3/4x16	-8	2.85	72	1.14	29	7/8	1.56	40	10	3.60	Y
S139HY-10-8	1/2	7/8x14	-10	3.01	76	1.26	32	1	1.72	44	10	3.72	Y
S139HY-10-10	5/8	7/8x14	-10	3.09	78	1.26	32	1	1.73	44	10	4.73	N
S139HY-12-8	1/2	1-1/16x12	-12	3.61	92	1.83	46	1-1/4	2.25	57	10	7.00	N
S139HY-12-10	5/8	1-1/16x12	-12	3.61	92	1.89	48	1-1/4	2.25	57	10	7.00	N
S139HY-12-12	3/4	1-1/16x12	-12	3.68	93	1.89	48	1-1/4	2.15	55	5	3.50	Y
S139HY-16-12	3/4	1-5/16x12	-16	4.33	110	2.14	54	1-1/2	2.78	71	5	4.30	N
S139HY-16-16	1	1-5/16x12	-16	4.31	109	2.31	59	1-1/2	2.69	68	5	4.78	Y

\*\* Stock: "Y" indicates stocked item; "N" indicates non-stocked item. Stock status subject to change. Contact Parker Customer Service.

Couplings: Refer to CrimpSource at [www.safehose.com](http://www.safehose.com) for coupling recommendations and crimp specifications.



## Series 43

### S10143 Male NPTF Pipe – Straight Rigid

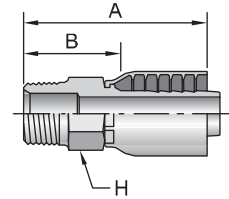

Part Number	Hose ID (in)	Thread ID (in)	Thread Dash Size	Dimensions					Std Pack Qty (per carton)	Approx Wt Per Ctn (lbs)	Stock Status **
				A (in)	A (mm)	H (in)	B (in)	B (mm)			
S10143-4-4	1/4	1/4x18	-4	2.01	51	9/16	1.26	32	25	3.00	Y
S10143-6-6	3/8	3/8x18	-6	2.37	60	3/4	1.34	34	25	4.25	Y
S10143-8-8	1/2	1/2x14	-8	2.84	72	7/8	1.58	40	20	5.30	Y
S10143-12-12	3/4	3/4x14	-12	3.09	78	1-1/16	1.65	42	10	4.35	Y
S10143-16-16	1	1x11-1/2	-16	2.59	66	1-3/8	1.97	50	5	3.71	Y
S10143-20-20	1-1/4	1-1/4x11-1/2	-20	4.08	104	1-3/4	2.39	61	5	5.50	Y
S10143-24-24	1-1/2	1-1/2x11-1/2	-24	3.50	89	2	2.13	54	5	8.06	Y
S10143-32-32	2	2x11-1/2	-32	4.05	103	2-1/2	2.27	58	5	13.37	Y

\*\* Stock: "Y" indicates stocked item; "N" indicates non-stocked item. Stock status subject to change. Contact Parker Customer Service.

## Series 43

### S10643 Female JIC 37° – Straight Swivel

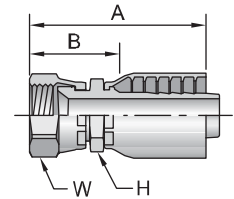

Part Number	Hose ID (in)	Thread ID (in)	Thread Dash Size	Dimensions					Std Pack Qty (per carton)	Approx Wt Per Ctn (lbs)	Stock Status **	
				A (in)	A (mm)	H (in)	W (in)	B (in)				B (mm)
S10643-4-4	1/4	7/16x20	-4	1.94	49	9/16	9/16	1.19	30	25	2.63	Y
S10643-6-6	3/8	9/16x18	-6	2.29	58	11/16	11/16	1.26	32	25	4.33	Y
S10643-8-8	1/2	3/4x16	-8	2.63	67	13/16	7/8	1.37	35	20	5.14	Y
S10643-12-12	3/4	1-1/16x12	-12	3.17	81	1-1/16	1-1/4	1.73	44	5	2.35	Y
S10643-16-16	1	1-5/16x12	-16	3.62	92	1-3/8	1-1/2	2.00	51	5	4.15	Y
S10643-20-20	1-1/4	1-5/8x12	-20	3.94	100	1-7/8	2	2.25	57	5	7.60	Y
S10643-24-24	1-1/2	1-7/8x12	-24	3.84	98	2-1/8	2-1/4	2.47	63	2	4.00	Y
S10643-32-32	2	2-1/2x12	-32	4.73	120	2-1/2	2-7/8	2.95	75	1	3.08	Y

\*\* Stock: "Y" indicates stocked item; "N" indicates non-stocked item. Stock status subject to change. Contact Parker Customer Service.

**Couplings:** Refer to CrimpSource at [www.safehose.com](http://www.safehose.com) for coupling recommendations and crimp specifications.

**Parker Industrial Hose Customer Service**  
 866 810 HOSE (4673) 800 242 HOSE (4673)  
 Strongsville, OH South Gate, CA  
 Eastern USA Western USA

[www.safehose.com](http://www.safehose.com)  
 e-mail: [indhose@parker.com](mailto:indhose@parker.com)

379



## Series 43

### S11343 Male NPTF Pipe – Straight Swivel

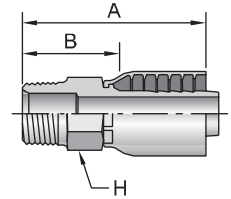

Part Number	Hose ID (in)	Thread ID (in)	Thread Dash Size	Dimensions					Std Pack Qty (per carton)	Approx Wt Per Ctn (lbs)	Stock Status **
				A (in)	A (mm)	H (in)	B (in)	B (mm)			
S11343-4-4	1/4	1/4X18	-4	2.68	68	5/8	1.93	49	10	1.53	N
S11343-6-6	3/8	3/8X18	-6	3.08	78	3/4	2.05	52	10	2.55	Y
S11343-8-8	1/2	1/2X14	-8	3.52	89	7/8	2.26	57	10	3.70	Y

\*\* Stock: "Y" indicates stocked item; "N" indicates non-stocked item. Stock status subject to change. Contact Parker Customer Service.

## Series 71

### S10171 Male NPTF Pipe – Straight Rigid

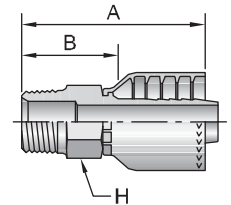

Part Number	Hose ID (in)	Thread ID (in)	Thread Dash Size	Dimensions					Std Pack Qty (per carton)	Approx Wt Per Ctn (lbs)	Stock Status **
				A (in)	A (mm)	H (in)	B (in)	B (mm)			
S10171-20-20	1-1/4	1-1/4x11-1/2	-20	4.06	103	1-3/4	2.39	61	2	2.50	Y
S10171-24-24	1-1/2	1-1/2x11-1/2	-24	4.32	110	2	2.19	56	1	2.02	Y
S10171-32-32	2	2x11-1/2	-32	4.66	118	2-1/2	2.52	64	2	6.45	Y

\*\* Stock: "Y" indicates stocked item; "N" indicates non-stocked item. Stock status subject to change. Contact Parker Customer Service.

## Series WC

### S1APWC Male API – Straight Rigid

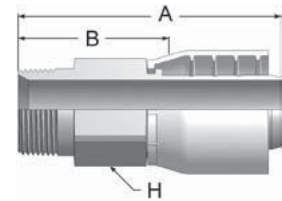

Part Number	Hose ID (in)	Thread ID (in)	Thread Dash Size	Dimensions					Std Pack Qty (per carton)	Approx Wt Per Ctn (lbs)	Stock Status **
				A (in)	A (mm)	H (in)	B (in)	B (mm)			
S1APWC-32-32	2	2x11-1/2	-32	7.17	182	2-5/8	3.92	99	2	2.00	Y

\*\* Stock: "Y" indicates stocked item; "N" indicates non-stocked item. Stock status subject to change. Contact Parker Customer Service.

**Couplings:** Refer to CrimpSource at [www.safehose.com](http://www.safehose.com) for coupling recommendations and crimp specifications.





## Series WC

### S101WC Male NPTF Pipe – Straight Rigid

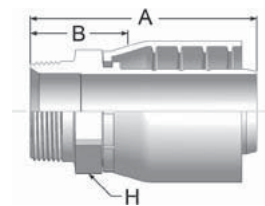

Part Number	Hose ID (in)	Thread ID (in)	Thread Dash Size	Dimensions						Std Pack Qty (per carton)	Approx Wt Per Ctn (lbs)	Stock Status **
				A (in)	A (mm)	H (in)	B (in)	B (mm)				
S101WC-32-32	2	2x11-1/2	-32	5.39	137	2-5/8	2.14	54	2	2.00	Y	

\*\* Stock: "Y" indicates stocked item; "N" indicates non-stocked item. Stock status subject to change. Contact Parker Customer Service.

## Series WC

### S106WC Female JIC 37° – Straight Swivel

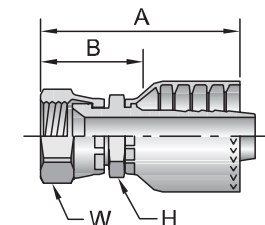

Part Number	Hose ID (in)	Thread ID (in)	Thread Dash Size	Dimensions						Std Pack Qty (per carton)	Approx Wt Per Ctn (lbs)	Stock Status **
				A (in)	A (mm)	H (in)	W (in)	B (in)	B (mm)			
S106WC-32-32	2	2-1/2x12	-32	5.95	151	2-5/8	2-7/8	2.70	69	2	2.00	Y

\*\* Stock: "Y" indicates stocked item; "N" indicates non-stocked item. Stock status subject to change. Contact Parker Customer Service.

## Series 7661/TY-FA

### Female SAE 45° – Straight Swivel

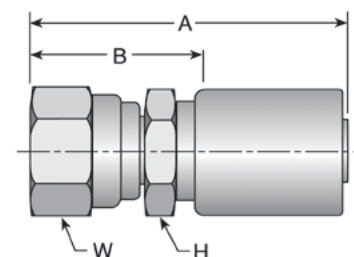

Part Number	Hose ID (in)	Thread ID (in)	Thread Dash Size	Dimensions						Std Pack Qty (per carton)	Approx Wt Per Ctn (lbs)	Stock Status **
				A (in)	A (mm)	H (in)	W (in)	B (in)	B (mm)			
7661-06FA04TY	1/4	5/8x18	-6	2.72	69	11/16	3/4	1.38	35	20	2.20	Y
7661-08FA08TY	1/2	3/4x16	-8	2.91	74	7/8	7/8	1.405	36	20	4.20	N
7661-10FA10TY	5/8	7/8x14	-10	3.06	78	1-1/8	1	1.69	43	20	6.20	N

\*\* Stock: "Y" indicates stocked item; "N" indicates non-stocked item. Stock status subject to change. Contact Parker Customer Service.

**Couplings:** Refer to CrimpSource at [www.safehose.com](http://www.safehose.com) for coupling recommendations and crimp specifications.

Parker Industrial Hose Customer Service  
 866 810 HOSE (4673) 800 242 HOSE (4673)  
 Strongsville, OH South Gate, CA  
 Eastern USA Western USA

[www.safehose.com](http://www.safehose.com)  
 e-mail: [indhose@parker.com](mailto:indhose@parker.com)

381



## Series 7661/TY-FF Female NPTF Pipe – Straight Rigid

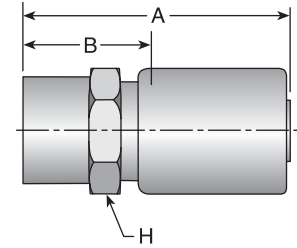

Part Number	Hose ID (in)	Thread ID (in)	Thread Dash Size	Dimensions						Std Pack Qty (per carton)	Approx Wt Per Ctn (lbs)	Stock Status **
				A (in)	A (mm)	H (in)	B (in)	B (mm)				
7661-04FF04TY	1/4	1/4x18	-4	2.47	63	11/16	1.15	26	25	3.23	Y	

\*\* Stock: "Y" indicates stocked item; "N" indicates non-stocked item. Stock status subject to change. Contact Parker Customer Service.

## Series 7661/TY-FJ Female JIC 37° – Straight Swivel

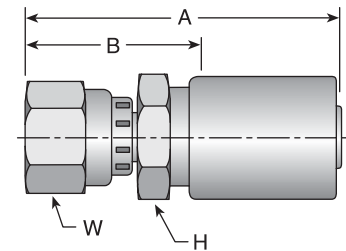

Part Number	Hose ID (in)	Thread ID (in)	Thread Dash Size	Dimensions						Std Pack Qty (per carton)	Approx Wt Per Ctn (lbs)	Stock Status **
				A (in)	A (mm)	H (in)	W (in)	B (in)	B (mm)			
7661-04FJ04TY	1/4	7/16x20	-4	2.60	66	9/16	9/16	1.25	32	25	3.18	Y
7661-08FJ08TY	1/2	3/4x16	-8	2.90	74	7/8	7/8	1.56	40	25	6.60	Y
7661-10FJ08TY	1/2	7/8x14	-10	2.98	76	1	1	1.63	41	20	5.28	Y

\*\* Stock: "Y" indicates stocked item; "N" indicates non-stocked item. Stock status subject to change. Contact Parker Customer Service.

## Series 7661/TY-MP Male NPTF Pipe – Straight Rigid

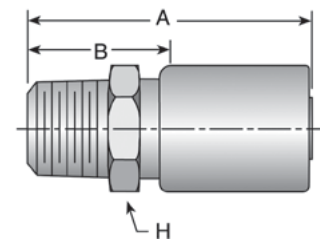

Part Number	Hose ID (in)	Thread ID (in)	Thread Dash Size	Dimensions						Std Pack Qty (per carton)	Approx Wt Per Ctn (lbs)	Stock Status **
				A (in)	A (mm)	H (in)	B (in)	B (mm)				
7661-04MP04TY	1/4	1/4x18	-4	2.53	64	9/16	1.19	30	50	7.00	Y	
7661-06MP08TY	1/2	3/8x18	-6	2.72	69	7/8	1.38	35	20	6.00	N	
7661-08MP08TY	1/2	1/2x14	-8	2.91	74	7/8	1.56	40	50	15.00	Y	
7661-12MP08TY	1/2	3/4x14	-12	2.91	74	1-1/16	1.56	40	20	6.00	Y	

\*\* Stock: "Y" indicates stocked item; "N" indicates non-stocked item. Stock status subject to change. Contact Parker Customer Service.

**Couplings:** Refer to CrimpSource at [www.safehose.com](http://www.safehose.com) for coupling recommendations and crimp specifications.



## Series 7661/TY-SP Male NPTF Pipe – Straight Swivel

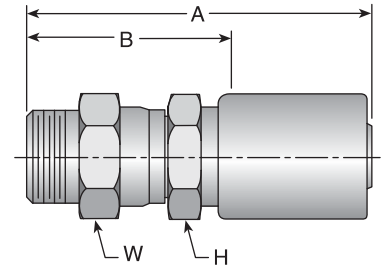

Part Number	Hose ID (in)	Thread ID (in)	Thread Dash Size	Dimensions						Std Pack Qty (per carton)	Approx Wt Per Ctn (lbs)	Stock Status **
				A (in)	A (mm)	H (in)	W (in)	B (in)	B (mm)			
7661-08SP08TY	1/2	1/2x14	-8	3.50	89	7/8	7/8	2.16	55	25	8.55	Y

\*\* Stock: "Y" indicates stocked item; "N" indicates non-stocked item. Stock status subject to change. Contact Parker Customer Service.

## Series 7661/LA-FJ Female JIC 37° – Straight Swivel

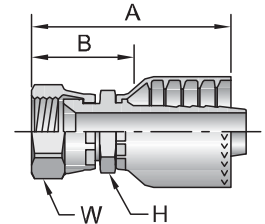

Part Number	Hose ID (in)	Thread ID (in)	Thread Dash Size	Dimensions						Std Pack Qty (per carton)	Approx Wt Per Ctn (lbs)	Stock Status **
				A (in)	A (mm)	H (in)	W (in)	B (in)	B (mm)			
7661-32FJ32LA	2	2-1/2x12	-32	5.39	137	2-5/8	2-7/8	2.70	69	7	27.20	Y

\*\* Stock: "Y" indicates stocked item; "N" indicates non-stocked item. Stock status subject to change. Contact Parker Customer Service.

## Series 7661/LA-NP Male NPTF Pipe – Straight Rigid

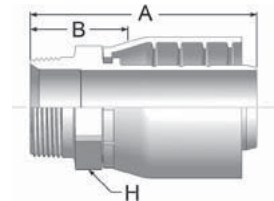

Part Number	Hose ID (in)	Thread ID (in)	Thread Dash Size	Dimensions						Std Pack Qty (per carton)	Approx Wt Per Ctn (lbs)	Stock Status **
				A (in)	A (mm)	H (in)	B (in)	B (mm)	H (in)			
7661-32NP32LA	2	2x11-1/2	-32	5.39	137	2-5/8	2.14	54	8	26.90	Y	

\*\* Stock: "Y" indicates stocked item; "N" indicates non-stocked item. Stock status subject to change. Contact Parker Customer Service.

**Couplings:** Refer to CrimpSource at [www.safehose.com](http://www.safehose.com) for coupling recommendations and crimp specifications.

**Parker Industrial Hose Customer Service**  
866 810 HOSE (4673) 800 242 HOSE (4673)  
Strongsville, OH South Gate, CA  
Eastern USA Western USA

[www.safehose.com](http://www.safehose.com)  
e-mail: [indhose@parker.com](mailto:indhose@parker.com)

383



## Series 7661/LAR-FJ Female JIC 37° – Straight Swivel with Internal O-Ring

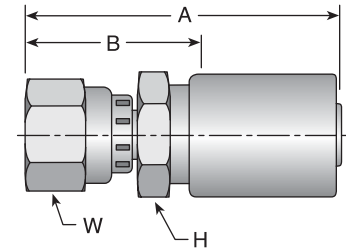

Part Number	Hose ID (in)	Thread ID (in)	Thread Dash Size	Dimensions						Std Pack Qty (per carton)	Approx Wt Per Ctn (lbs)	Stock Status **
				A (in)	A (mm)	H (in)	W (in)	B (in)	B (mm)			
7661-16FJ16LAR	1	1-5/16x12	-16	3.55	90	1-3/8	1-3/8	1.81	46	25	17.15	Y

\*\* Stock: "Y" indicates stocked item; "N" indicates non-stocked item. Stock status subject to change. Contact Parker Customer Service.

## Series 7661/LAR-MP Male NPTF Pipe – Straight Rigid with Internal O-Ring

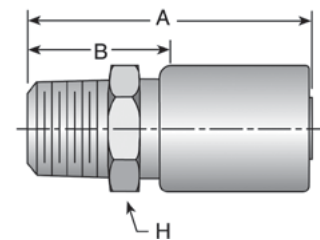

Part Number	Hose ID (in)	Thread ID (in)	Thread Dash Size	Dimensions					Std Pack Qty (per carton)	Approx Wt Per Ctn (lbs)	Stock Status **
				A (in)	A (mm)	H (in)	B (in)	B (mm)			
7661-16MP16LAR	1	1x11-1/2	-16	3.42	87	1-3/8	1.69	43	25	15.73	Y

\*\* Stock: "Y" indicates stocked item; "N" indicates non-stocked item. Stock status subject to change. Contact Parker Customer Service.

## Series CS S101CS Male NPTF Pipe – Straight Rigid

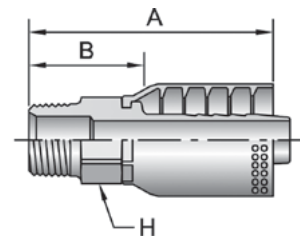

Part Number	Hose ID (in)	Thread ID (in)	Thread Dash Size	Dimensions					Std Pack Qty (per carton)	Approx Wt Per Ctn (lbs)	Stock Status **
				A (in)	A (mm)	H (in)	B (in)	B (mm)			
S101CS-12-12	3/4	3/4x14	-12	3.56	90	1-1/8	1.75	44	25	16.05	Y
S101CS-16-16	1	1x11-1/2	-16	3.94	100	1-3/8	2.00	51	25	27.43	Y

\*\* Stock: "Y" indicates stocked item; "N" indicates non-stocked item. Stock status subject to change. Contact Parker Customer Service.

**Couplings:** Refer to CrimpSource at [www.safehose.com](http://www.safehose.com) for coupling recommendations and crimp specifications.



## Series 7610/CS Crimp Coupling for Steam Hose Female Ground Joint NPSM with Wing Nut and O-Ring

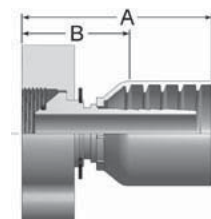

Part Number	Description	Hose ID (in)	Thread (in)	Dimensions				Std Pack Qty (per carton)	Approx Wt Per Each (lbs)	Stock Status **
				A (in)	A (mm)	B (in)	B (mm)			
7610-12CSGJF	With Wing Nut	3/4	1-1/2	3.70	94	1.57	40	Per Order	1.00	Y
7610-12CSGJFS	Spud	3/4	1-1/2	n/a	n/a	n/a	n/a	Per Order	1.00	Y
7610-16CSGJF	With Wing Nut	1	1-1/2	3.97	100	1.53	39	Per Order	1.00	Y

\*\* Stock: "Y" indicates stocked item; "N" indicates non-stocked item. Stock status subject to change. Contact Parker Customer Service.

## Series 7612 Spud Adapter for Steam Hose

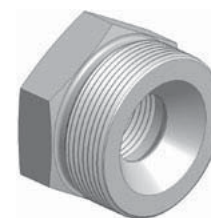

Part Number	Description	Std Pack Qty (per carton)	Approx Wt Per Ctn (lbs)	Stock Status **
7612-750GFS3	3/4" Female Pipe Straight to 1-1/2" Ground Joint Male	10	10.00	Y

\*\* Stock: "Y" indicates stocked item; "N" indicates non-stocked item. Stock status subject to change. Contact Parker Customer Service.

## Series 20 Reattachable Couplings for LPG Fuel Hose Female SAE 45° – Straight Swivel

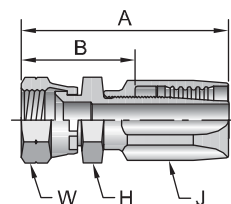

Part Number	Hose ID (in)	Thread ID (in)	Thread Dash Size	Dimensions							Std Pack Qty (per carton)	Approx Wt Per Ctn (lbs)	Stock Status **
				A (in)	A (mm)	H (in)	J (in)	W (in)	B (in)	B (mm)			
S20820-6-6	5/16	5/8x18	-6	2.36	60	3/4	13/16	3/4	1.44	37	25	4.20	Y

\*\* Stock: "Y" indicates stocked item; "N" indicates non-stocked item. Stock status subject to change. Contact Parker Customer Service.

## Series CGHBL Brass Stem for Welding Hose NOTE: Use D Nuts

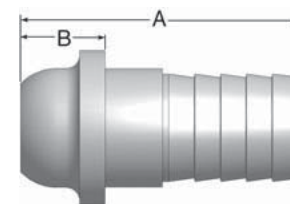

Part Number	Hose ID (in)	Dimensions				Std Pack Qty (per carton)	Approx Wt Per Each (lbs)	Stock Status **
		A (in)	A (mm)	B (in)	B (mm)			
CGHBL-12-12	3/4	2.26	57	0.62	16	Per Order	0.50	Y

\*\* Stock: "Y" indicates stocked item; "N" indicates non-stocked item. Stock status subject to change. Contact Parker Customer Service.

**Couplings:** Refer to CrimpSource at [www.safehose.com](http://www.safehose.com) for coupling recommendations and crimp specifications.

Parker Industrial Hose Customer Service  
866 810 HOSE (4673) 800 242 HOSE (4673)  
Strongsville, OH South Gate, CA  
Eastern USA Western USA

[www.safehose.com](http://www.safehose.com)  
e-mail: [indhose@parker.com](mailto:indhose@parker.com)

385



## Series HBL-C 304 Stainless Steel Male BSPP w/Seal – Straight Rigid For Series 7116M and 7215 DEF Hose

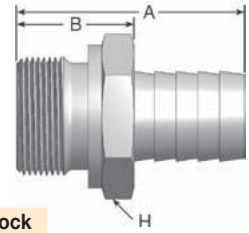

Part Number	Hose ID (in)	Thread ID (in)	Thread Dash Size	Dimensions					Std Pack Qty (per carton)	Approx Wt Per Ctn (lbs)	Stock Status **
				A (in)	A (mm)	H (in)	B (in)	B (mm)			
<b>S1D00NMHBL-12-12C</b>	3/4	3/4x14	-12	2.00	51	1-1/4	1.03	26	25	4.36	Y

\*\* Stock: "Y" indicates stocked item; "N" indicates non-stocked item. Stock status subject to change. Contact Parker Customer Service.

**NOTE:** Requires SMCP24631 or SMCP24633 ferrules.

## Series HBL-C 304 Stainless Steel Male NPTF Pipe – Straight Rigid For Series 7116M and 7215 DEF Hose

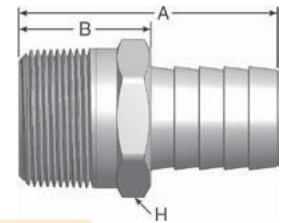

Part Number	Hose ID (in)	Thread ID (in)	Thread Dash Size	Dimensions					Std Pack Qty (per carton)	Approx Wt Per Ctn (lbs)	Stock Status **
				A (in)	A (mm)	H (in)	B (in)	B (mm)			
<b>S125HBL-12-12C</b>	3/4	3/4x14	-12	1.98	50	1-1/16	1.01	26	25	4.36	Y

\*\* Stock: "Y" indicates stocked item; "N" indicates non-stocked item. Stock status subject to change. Contact Parker Customer Service.

**NOTE:** Requires SMCP24631 or SMCP24633 ferrules.

## Series SMCP Nickel Plated Brass Ferrule



Part Number	Hose Series	Hose ID (in)	Ferrule ID (in)	Ferrule ID (in)	Ferrule ID (mm)	Std Pack Qty (per carton)	Approx Wt Per Ctn (lbs)	Stock Status **
<b>SMCP24631</b>	7215	3/4	1.225	0.968	24.6	25	2.50	Y
<b>SMCP24633</b>	7116M	3/4	1.200	0.843	21.4	25	2.50	Y

\*\* Stock: "Y" indicates stocked item; "N" indicates non-stocked item. Stock status subject to change. Contact Parker Customer Service.

**Couplings:** Refer to CrimpSource at [www.safehose.com](http://www.safehose.com) for coupling recommendations and crimp specifications.

# Composite Hose Standard Factory Couplings

Coupling End Style	Coupling Material Standard Hose Series 1000, 2100	Coupling Material Standard Hose Series 31000, 4100, 5100	Coupling Material Standard Hose Series 4500	Hose I.D.									
				1"	1-1/2"	2"	2-1/2"	3"	4"	6"	8"	10"	
Cam & Groove Female	Carbon Steel (Aluminum optional)	316 Stainless Steel	n/a	■	■	■	■	■	■				
Cam & Groove Male	Carbon Steel (Aluminum optional)	316 Stainless Steel	n/a	■	■	■	■	■	■				
Ferrules	Carbon Steel	304 Stainless Steel (316SS optional)	Carbon Steel	■	■	■	■	■	■	■	■	■	■
Flange Fixed or Floating ANSI 150#	Carbon Steel	304 Stainless Steel (316SS optional)	n/a			■		■	■	■	■	■	■
Flange Fixed or Floating ANSI 300#	Carbon Steel	304 Stainless Steel (316SS optional)	n/a			■		■	■	■	■	■	■
Flange Stem	Carbon Steel	316 Stainless Steel	n/a			■		■	■	■	■	■	■
Male Pipe Stem	Carbon Steel	316 Stainless Steel	n/a	■	■	■	■	■	■	■	■		
TTMA (Truck Trailer Mfrs Assn)	n/a	n/a	Carbon Steel					■	■				

Refer to the **Composite Hose** section of this catalog for specific hose information.

**Couplings:** Refer to CrimpSource at [www.safehose.com](http://www.safehose.com) for coupling recommendations and crimp specifications.

# COS-K1

## Adjustable Crimper

The COS-K1 is a versatile adjustable crimper that provides accurate, reliable, repeatable, quick and easy crimping for hose up to 1-1/4" ID.

- 60 tons of crimping force
- 1.0 horsepower hydraulic pump
- 115 VAC single phase power
- Bench mountable
- Capability:
  - to 1-1/4" industrial hose
  - to 1-1/4" 4-spiral wire hose



Part Number	Description	Die Closure (in)	Dimensions	Approx Wt (lbs)	Stock Status **	Availability
COS-K1	115 VAC, 1-phase		12.5" W x 22" L x 22.5" H	140	N	
COS-K2-SHELF	Die storage rack			43	N	Included
COS-K2-STAND	Crimper stand			50	N	Optional
	Pusher plate				N	Included
EN98-020-01S	Split die set, red	0.520		4	N	Optional
EN98-020-02S	Split die set, yellow	0.670		4	N	Optional
EN98-020-03S	Split die set, blue	0.830		4	N	Optional
EN98-020-04S	Split die set, green	1.100		4	N	Optional
EN98-020-05S	Split die set, black	1.320		4	N	Optional
EN98-020-06S	Split die set, brown	1.500		4	N	Optional
EN98-020-07S	Split die set, clear	1.730		4	N	Optional
EN98-020-08S	Split die set, purple	1.920		4	N	Optional

Solid die sets available. Contact Parker Customer Service.

\*\* Stock: "Y" indicates stocked item; "N" indicates non-stocked item. Stock status subject to change. Contact Parker Customer Service.

**Couplings:** Refer to CrimpSource at [www.safehose.com](http://www.safehose.com) for coupling recommendations and crimp specifications.





# COS-K2

## Adjustable Crimper

The COS-K2 is a versatile adjustable crimper that provides accurate, reliable, repeatable, quick and easy crimping for hose up to 2" ID.

- 80 tons of crimping force
- 2.0 horsepower hydraulic pump
- 115 VAC single phase power
- Bench mountable
- Capability:
  - to 2" industrial hose
  - to 2" 4-spiral wire hose
  - to 1-1/2" 6-spiral wire hose



Part Number	Description	Die Closure (in)	Dimensions	Approx Wt (lbs)	Stock Status **	Availability
COS-K2	115 VAC, 1-phase		17" W x 32" L x 29" H	375	N	
COS-K2-SHELF	Die storage rack			43	N	Optional
COS-K2-STAND	Crimper stand			50	N	Optional
	Pusher plate				N	Included
EN98-020-01S	Split die set, red	0.520		4	N	Optional
EN98-020-02S	Split die set, yellow	0.670		4	N	Optional
EN98-020-03S	Split die set, blue	0.830		4	N	Optional
EN98-020-04S	Split die set, green	1.100		4	N	Optional
EN98-020-05S	Split die set, black	1.320		4	N	Optional
EN98-020-06S	Split die set, brown	1.500		4	N	Optional
EN98-020-07S	Split die set, clear	1.730		4	N	Optional
EN98-020-08S	Split die set, purple	1.920		4	N	Optional
EN98-032-05S	Split die set, pink	2.140		17	N	Optional
EN98-032-01S	Split die set, pink	2.300		17	N	Optional
EN98-032-06S	Split die set, tan	2.500		17	N	Optional
EN98-032-02S	Split die set, white	2.800		17	N	Optional

Solid die sets available. Contact Parker Customer Service.

\*\* Stock: "Y" indicates stocked item; "N" indicates non-stocked item. Stock status subject to change. Contact Parker Customer Service.

**Couplings:** Refer to CrimpSource at [www.safehose.com](http://www.safehose.com) for coupling recommendations and crimp specifications.

**Parker Industrial Hose Customer Service**  
 866 810 HOSE (4673)    800 242 HOSE (4673)  
 Strongsville, OH    South Gate, CA  
 Eastern USA    Western USA

[www.safehose.com](http://www.safehose.com)  
 e-mail: [indhose@parker.com](mailto:indhose@parker.com)

# COS-K4

## Adjustable Crimper

### Electronic Crimp Setting/Adjustment

The COS-K4 is a versatile adjustable crimper that provides accurate, reliable, repeatable, quick and easy crimping for hose up to 4" ID.

- 265 tons of crimping force
- 7.5 horsepower hydraulic pump, 8 gallon reservoir (5 horsepower pump for single phase model)
- Available in 3 models:
  - 208-230 VAC 1-phase
  - 208-230 VAC 3-phase
  - 440-480 VAC 3-phase
- Master die ID: 145mm
- Master die opening without dies: 205mm
- Master die opening with dies: Die diameter + 60mm
- Maximum crimping diameter: 136mm
- Electronic crimp setting/adjustment
- Manual and automatic operation
- Heavy-duty base
- Capability:
  - to 4" industrial hose
  - to 2" 4-spiral wire hose
  - to 1-1/2" 6-spiral wire hose



K4 Crimper Stand

Part Number	Description	Die Closure (mm)	Die Length (mm)	Dimensions	Approx Wt (lbs)	Stock Status **	Availability
<b>COS-K4SP220</b>	208-230 VAC, 1-phase			18.3" W x 27.25" L x 31.25" H	573	N	
<b>COS-K4TP220</b>	208-230 VAC, 3-phase			18.3" W x 27.25" L x 31.25" H	573	N	
<b>COS-K4SP440</b>	440-480 VAC, 3-phase			18.3" W x 27.25" L x 31.25" H	573	N	
	Foot switch					N	Included
	Master die, 145mm					N	Included
	Adapter die, 145mm (for 99mm dies)					N	Included
<b>101247-99</b>	Crimper stand, storage rack, die-change tool for 99 mm dies				90	N	Optional
<b>EBS-60</b>	Back set-stop, electrical				5	N	Optional
<b>MBS-60</b>	Back set-stop, mechanical				6	N	Optional

(Continued on the following page)

**Couplings:** Refer to CrimpSource at [www.safehose.com](http://www.safehose.com) for coupling recommendations and crimp specifications.



## COS-K4, Industrial Hose Adjustable Crimper (Continued)

Part Number	Description	Die Closure (mm)	Die Length (mm)	Approx Wt (lbs)	Stock Status **	Availability
18506-07	Solid Die Set	7	55	4	N	Optional
18506-08	Solid Die Set	8	55	4	N	Optional
18506-10	Solid Die Set	10	55	4	N	Optional
18506-12	Solid Die Set	12	55	4	N	Optional
18506-14	Solid Die Set	14	55	4	N	Optional
18506-16	Solid Die Set	16	55	4	N	Optional
18506-19	Solid Die Set	19	55	4	N	Optional
18506-22	Solid Die Set	22	70	4	N	Optional
18506-26	Solid Die Set	26	70	4	N	Optional
18506-30	Solid Die Set	30	70	4	N	Optional
18506-34	Solid Die Set	34	75	4	N	Optional
18506-39	Solid Die Set	39	75	4	N	Optional
18506-45	Solid Die Set	45	90	4	N	Optional
18506-51	Solid Die Set	51	90	4	N	Optional
18506-57	Solid Die Set	57	100	4	N	Optional
18506-63	Solid Die Set	63	110	4	N	Optional
18506-69	Solid Die Set	69	110	4	N	Optional
18506-74	Solid Die Set	74	110	4	N	Optional
18506-78	Solid Die Set	78	110	4	N	Optional
145S-84-125	Solid Die Set	84	125	9	N	Optional
145S-88-130	Solid Die Set	88	130	9	N	Optional
145S-92-125	Solid Die Set	92	125	9	N	Optional
145S-96-125	Solid Die Set	96	125	9	N	Optional
145S-100-125	Solid Die Set	100	125	9	N	Optional
145S-108-125	Solid Die Set	108	125	9	N	Optional
145S-116-125	Solid Die Set	116	125	9	N	Optional
145S-120-125	Solid Die Set	120	125	9	N	Optional
145S-126-125	Solid Die Set	126	125	9	N	Optional

\*\* Stock: "Y" indicates stocked item; "N" indicates non-stocked item. Stock status subject to change. Contact Parker Customer Service.

**Couplings:** Refer to CrimpSource at [www.safehose.com](http://www.safehose.com) for coupling recommendations and crimp specifications.

# Vise Crimpers

## 660-T Manual / 670-T Air-Powered

The 660-T/670-T is a versatile, lightweight bench-mounted crimper for quick and easy crimping of low pressure industrial hose to 1" ID using barbed inserts and lightweight ferrules.

**NOTE:** Parker does not provide crimp specifications for these crimpers.



670-T Air Powered



660-T Manual

Part Number	Description	Die Closure (in)	Approx Wt (lbs)	Stock Status **	Availability
660-T	Manual unit		21	N	
660-TBS	Back stop, mechanical			N	Optional
	Detachable handle			N	Included
670-T	Air powered unit		95	N	
660-TBS	Back stop, mechanical			N	Included
	Air cylinder			N	Included
	Connector hose			N	Included
	Foot switch			N	Included
662-T-310	Die, smooth	0.310	1	N	Optional
662-T-350	Die, smooth	0.350	1	N	Optional
662-T-375	Die, smooth	0.375	1	N	Optional
662-T-400	Die, smooth	0.400	1	N	Optional
662-T-425	Die, smooth	0.425	1	N	Optional
662-T-450	Die, smooth	0.450	1	N	Optional
662-T-475	Die, smooth	0.475	1	N	Optional
662-T-500	Die, smooth	0.500	1	N	Optional
662-T-525	Die, smooth	0.525	1	N	Optional
662-T-550	Die, smooth	0.550	1	N	Optional
662-T-575	Die, smooth	0.575	1	N	Optional
662-T-600	Die, smooth	0.600	1	N	Optional
662-T-625	Die, smooth	0.625	1	N	Optional
662-T-650	Die, smooth	0.650	1	N	Optional
662-T-675	Die, smooth	0.675	1	N	Optional
662-T-700	Die, smooth	0.700	1	N	Optional
662-T-725	Die, smooth	0.725	1	N	Optional
662-T-750	Die, smooth	0.750	1	N	Optional
662-T-775	Die, smooth	0.775	1	N	Optional
662-T-800	Die, smooth	0.800	1	N	Optional
662-T-825	Die, smooth	0.825	1	N	Optional
662-T-850	Die, smooth	0.850	1	N	Optional
662-T-875	Die, smooth	0.875	1	N	Optional
662-T-900	Die, smooth	0.900	1	N	Optional
662-T-925	Die, smooth	0.925	1	N	Optional
662-T-950	Die, smooth	0.950	1	N	Optional
662-T-975	Die, smooth	0.975	1	N	Optional
662-T-1075	Die, smooth	1.075	1	N	Optional
662-T-1075H	Die, ribbed	1.075	1	N	Optional
662-T-1150	Die, smooth	1.150	1	N	Optional

\*\* Stock: "Y" indicates stocked item; "N" indicates non-stocked item. Stock status subject to change. Contact Parker Customer Service.